

Himlingssystemer



Armstrong **BURGESS CEP.** **DAMPA®**

Ecophon
SAINT-GOBAIN

FURAT

Gyproc
SAINT-GOBAIN

haag

HunterDouglas®

INLOOK®

KNAUF DANOLINE

META

OWA

PAROC

Rockfon

SAS
International

Troldtekt® 

















C90-R monteret i Dampa Clip-In

Innhold

Oversikt	3
Modulhimlinger	4-16
Synlig bæreprofil	4-5
Synlig bæreprofil med profilerte plater	6-7
Profilert synlig bæreprofil med profilerte plater	8
Skjult bæreprofil med symmetriske plater	9
Skjult 24 mm bæreprofil med asymmetriske plater	10-11
Skjult 35 mm bæreprofil med asymmetriske plater	12
Klemskinne 16 mm	13
Klemskinne 36 mm	14
Klemskinne 45 mm	15
Ikke demonterbare	16
Gipshimlinger	17
Bandraster	18
Spilehimlinger	19

Oversikt

		MODULÆRE HIMLINGER											Ikke demonterbare	Gipshimlinger
		DEMONTERBARE												
		SYNLIGE PROFILER				SKJULTE PROFILER								
		1524 mm	35 mm	1524 mm	15 mm	24 mm	Asy 24 mm	Asy 35 mm	16 mm	36 mm	45 mm	24 mm		
	A51-R G2	✓	✓	✓	✓	✓ ¹	✓ ¹		✓ ¹	✓ ¹	✓ ¹			
	C77-R	✓	✓	✓	✓	✓ ¹	✓ ¹	✓ ¹	✓ ¹	✓ ¹	✓ ¹		✓ ³	
	C30RIT G2	✓	✓	✓	✓								✓ ³	
	C30RIC G2					✓	✓	✓	✓	✓	✓			
	C25-R C35-R C95-R FLAT2	✓	✓	✓	✓								✓ ³	
	C70-R G2 C85-R	✓	✓	✓	✓							✓ ²	✓ ²	
	C90-R	✓	✓	✓	✓	✓ ¹			✓ ¹	✓ ¹			✓ ³	
	C91-R						✓				✓			
	C91-RE			✓ ⁴	✓ ⁴									
	C92-R							✓						
	C63-R	✓	✓	✓		✓	✓		✓	✓	✓			
	C64-R	✓		✓		✓			✓			✓	✓	
	C80-R G2	✓				✓ ¹	✓ ¹	✓ ¹					✓	
	MODERNA2-R	✓	✓	✓	✓								✓ ^{1/3}	

1 - Med monteringsbraketter som tilleggsutstyr

2 - Med monteringsramme som tilleggs utstyr

3 - Med ramme for gipshimling

4 - Kun på forespør sel

Modulhimlinger

Himlingssystemer begrenset i både længde og bredde, med enten synlige eller skjulte bæreprøfiler.

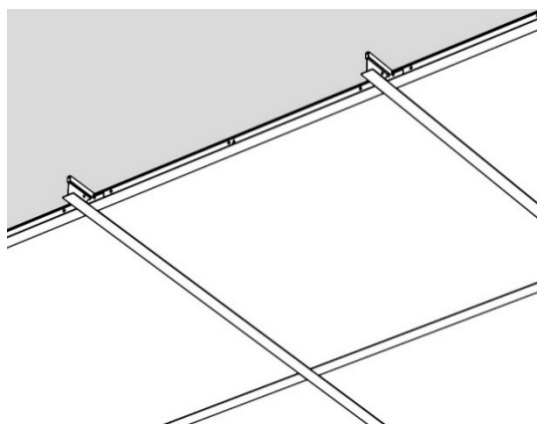

Synlig bæreprøfil

Synlig bæreprøfil

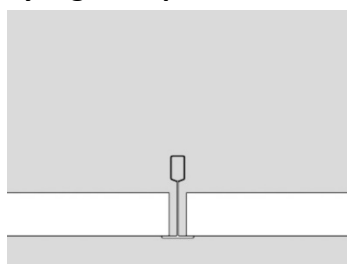

Ecophon A15

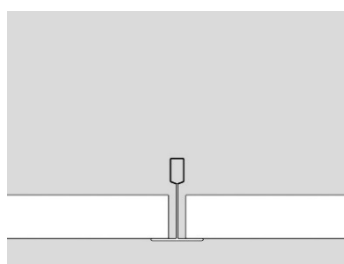

Ecophon A24

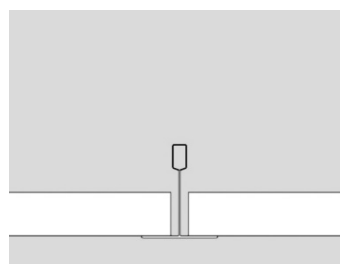

Armstrong Prelude 35

Eksempel på leverandører

AMF SK 15/24, Armstrong Prelude 15/24/35, Burgess Sequence 15/24, Ecophon A15/24, Gyproc Gyptone A15/24, Knauf Danoline A, Lindner LMD-K 403, OWA S 15/3, Paroc A, Rockfon A15/24, Trolldtekt K0-S 35

Våre tilpassede løsninger

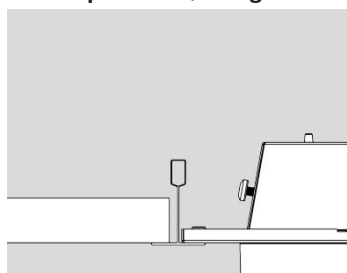

A51-R G2

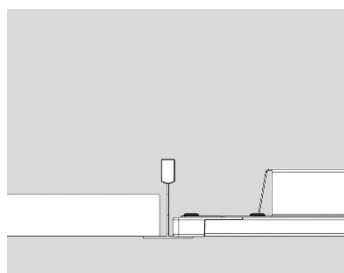

C77-R

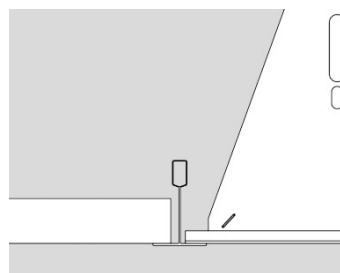

C30-RIT G2

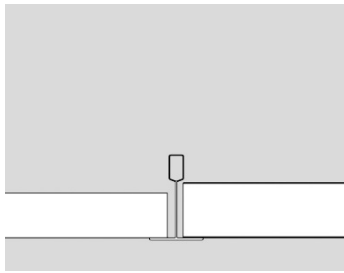

C25-R/C35-R/C95-R
FLAT2/MODERNA2-R

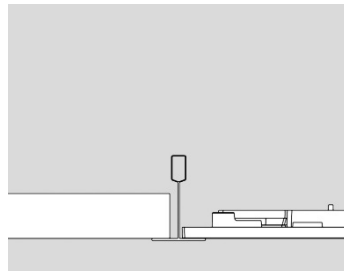

C70-R G2

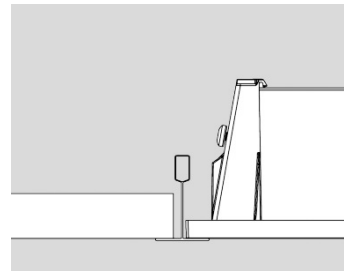

C90-R

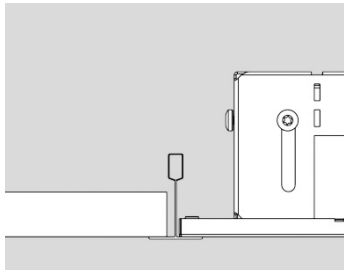

C63-R

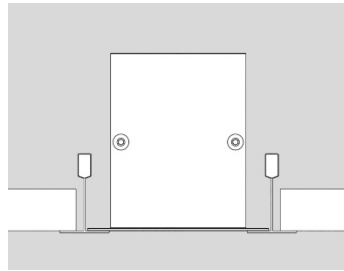

C80-R G2

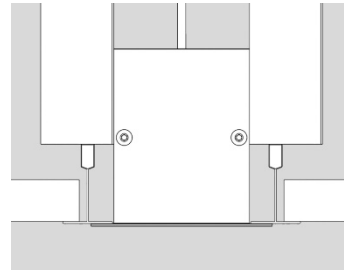

C80-R G2

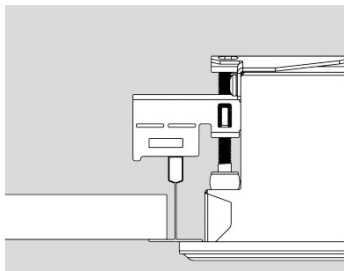

C64-R

Kan kun monteres under bæreprøfil ved hjelp av armaturens innebygde oppheng.

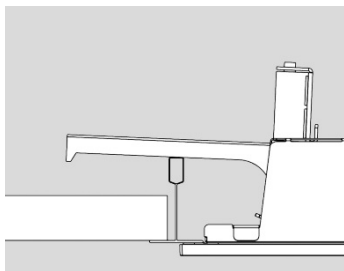

C70-R G2/C85-R
(+ MNT C70-R G2)

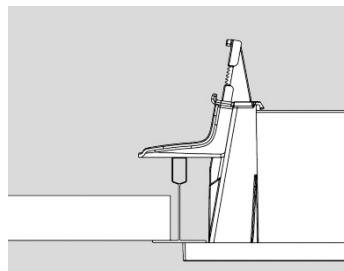

C90-R
(+ MNT C90-R)

Ønskes montasje under bæreprøfil anbefales bruk av C70-R G2 eller C90-R. Det kreves monteringssett som leveres som tilleggsmateriale.

Synlig bæreprøfil med profilerede plater

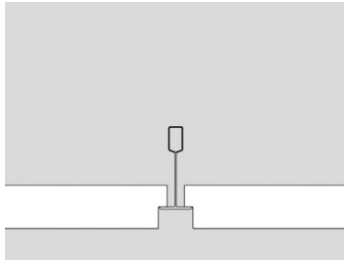

Rockfon E15S

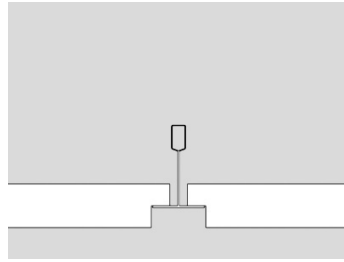

Rockfon E24S

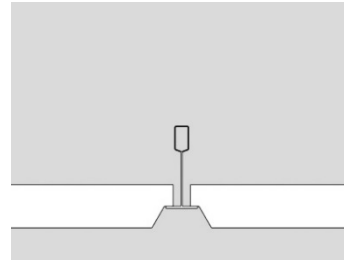

Himlingsplatenes profilering kan variere i form og dybde. Her representert ved Rockfon E15L.

Eksempel på leverandører

AMF VT 15/24, Armstrong Prelude 15/24, Burgess Sequence 15/24, Ecophon E15/24, Gyproc Gyptone E15, Knauf Danoline E/E+, Lindner LMD-K 400, OWA S 15A/3A, Paroc E15/E24, Rockfon E15/24, Troldekt K0/K3/K5-FS 35

Våre tilpassede løsninger

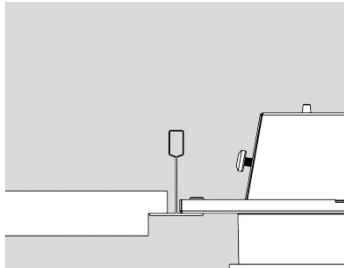

A51-R G2

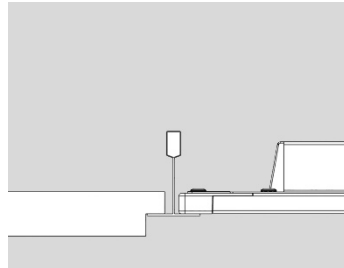

C77-R

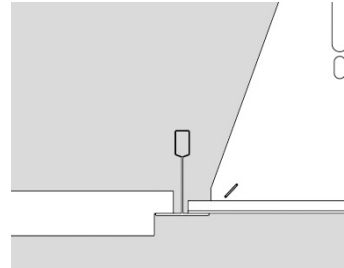

C30-RIT G2

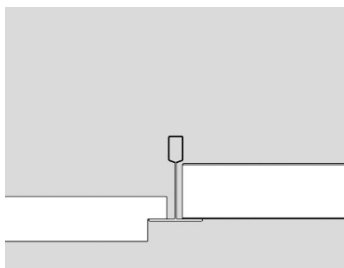

C25-R/C35-R/C95-R
FLAT2/MODERNA2-R

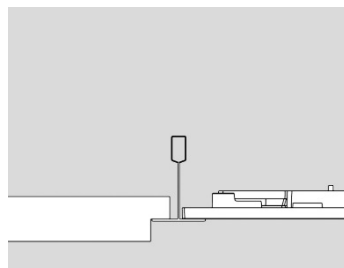

C70-R G2

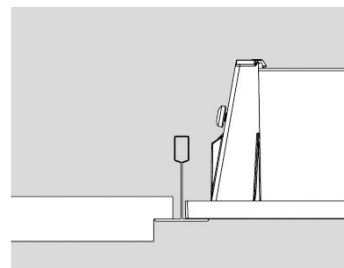

C90-R

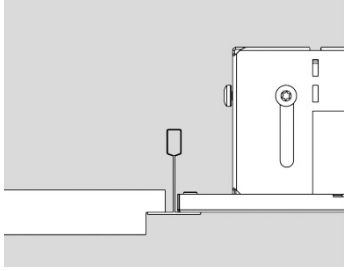

C63-R

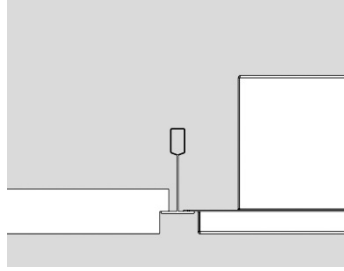

C91-RE (Kun på forespørsel)

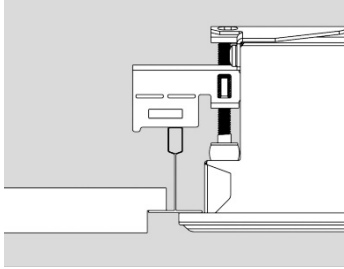

C64-R

Kan kun monteres under bæreprofil ved hjelp av armaturens innebygde oppheng.

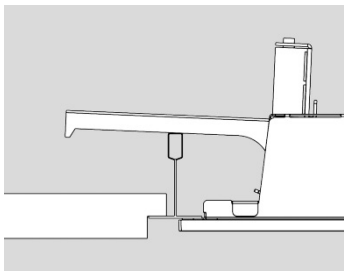

C70-R G2/C85-R
(+ MNT C70-R G2)

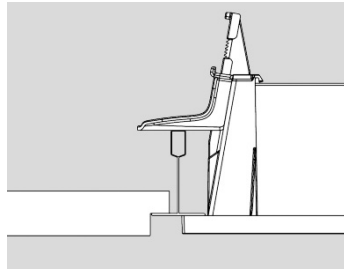

C90-R
(+ MNT C90-R)

Ønskes montasje under bæreprofil anbefales bruk av C70-R G2 eller C90-R. Det kreves monteringssett som leveres som tilleggsutstyr.

Profilert synlig bæreprfil med profilerte plater

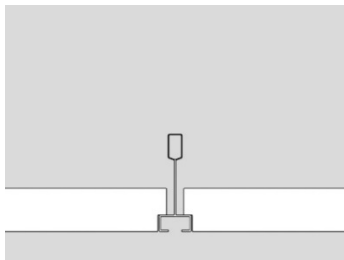

Armstrong Silhouette

Eksempel på leverandører

Armstrong Silhouette, OWA S 15B OWAline, Rockfon E15 Microline, SAS 130

Våre tilpassede løsninger

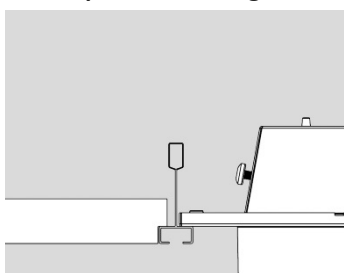

A51-R G2

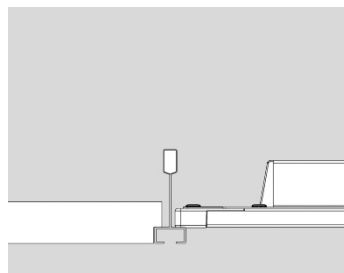

C77-R

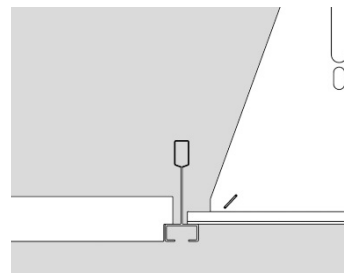

C30-RIT G2

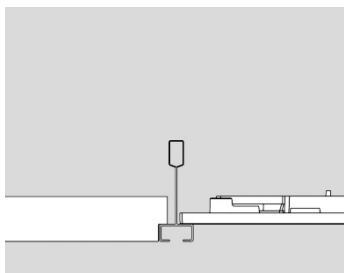

C70-R G2/C85-R

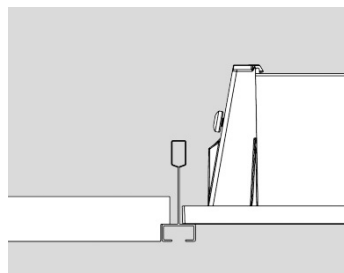

C90-R

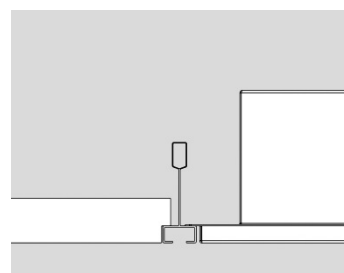

C91-RE (Kun på forespørsel)

Skjult bæreprofil med symmetriske plater

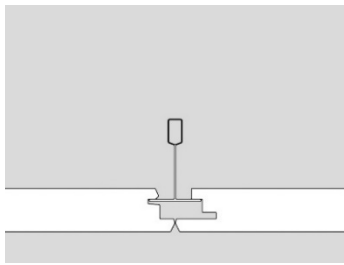

Ecophon Focus Ds

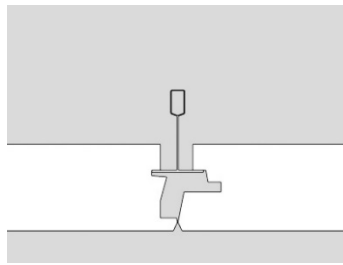

Ecophon Master Ds

Eksempel på leverandører

Burgess Sequence Shiplap T24, Ecophon Focus/Master Ds, Paroc D2, Rockfon T24X

Våre tilpassede løsninger

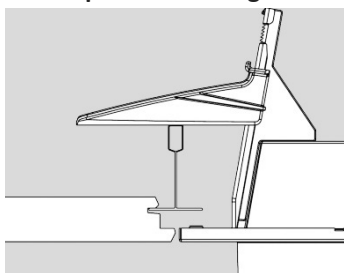

A51-R G2
(+ MNT C20-R G2)

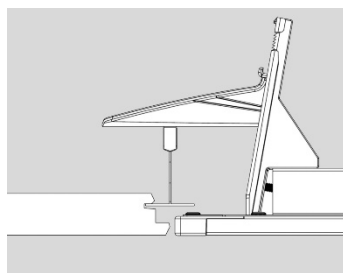

C77-R
(+ MNT C77-R)

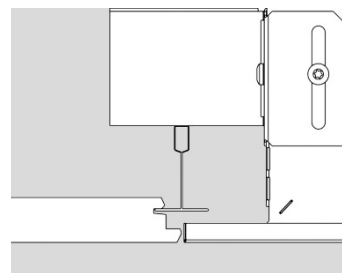

C30-RIC G2

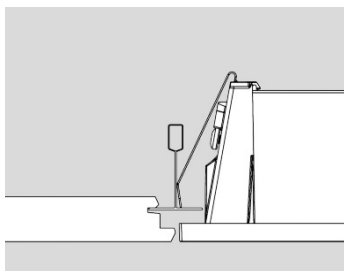

C90-R
(+ MNT CLICK-IN C90-R)

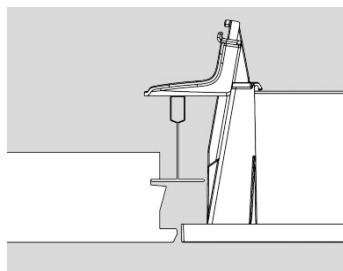

C90-R
(+ MNT C90)

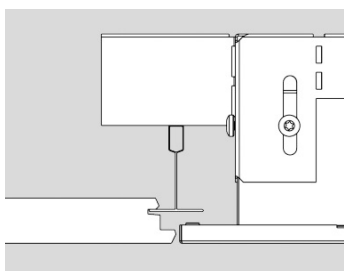

C91-R/C63-R

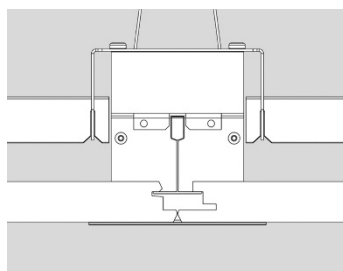

C80-R G2
(+MNT DS/T24X)

Skjult 24 mm bæreprøfil med asymmetriske plater

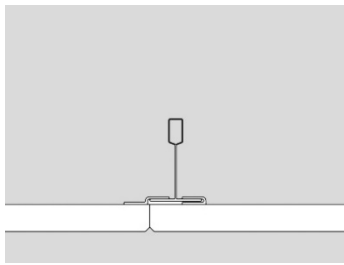

Gyproc Gyptone D1

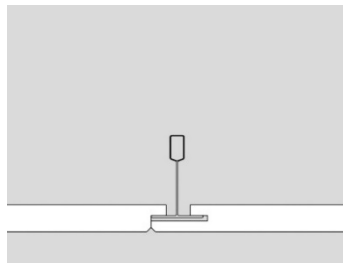

Gyproc Gyptone D2

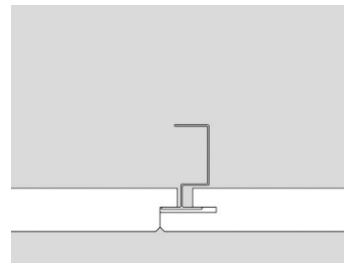

Rockfon D-XL

Eksempel på leverandører

AMF AW, Gyproc Gyptone D1/D2, Knauf Danoline D/D+, OWA S 9b, Paroc D, Rockfon D-XL/H

Våre tilpassede løsninger

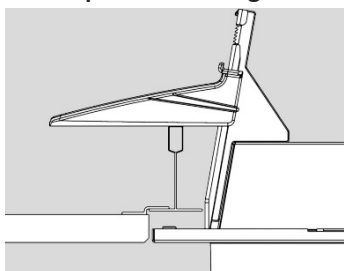

A51-R G2
(+ MNT C20-R G2)

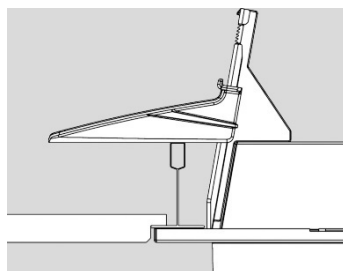

A51-R G2
(+ MNT C20-R G2)

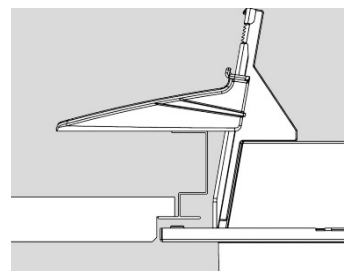

A51-R G2
(+ MNT C20-R G2)

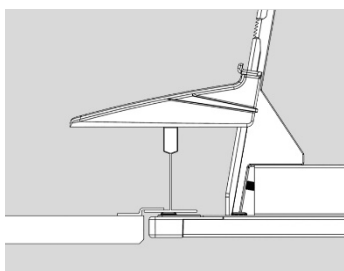

C77-R
(+ MNT C77-R)

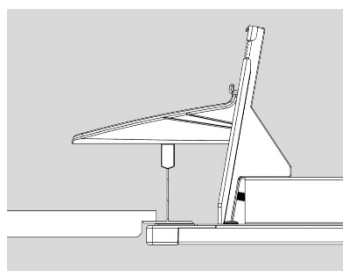

C77-R
(+ MNT C77-R)

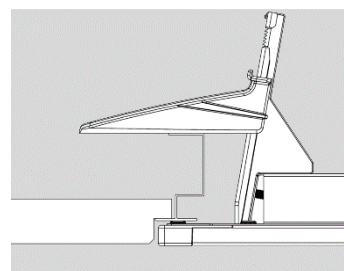

C77-R
(+ MNT C77-R)

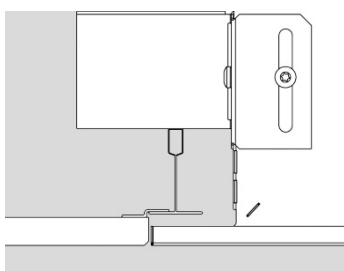

C30-RIC G2

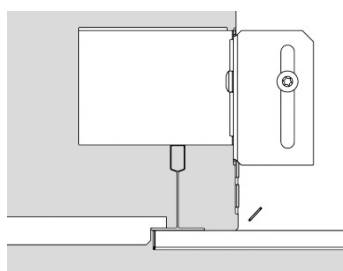

C30-RIC G2

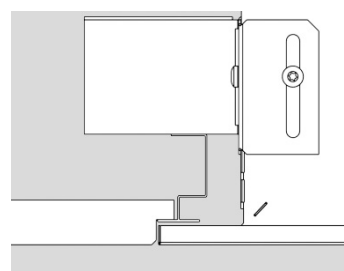

C30-RIC G2

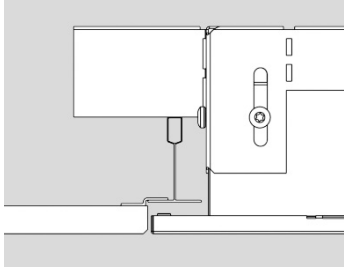

C91-R/C63-R

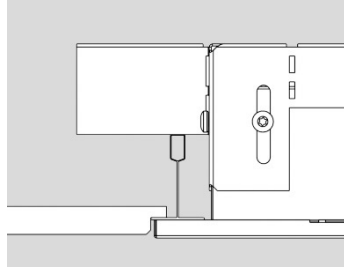

C91-R/C63-R

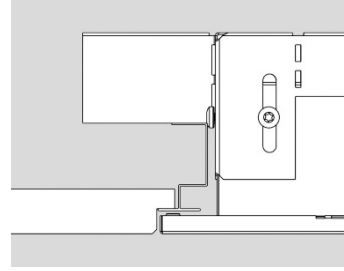

C91-R/C63-R

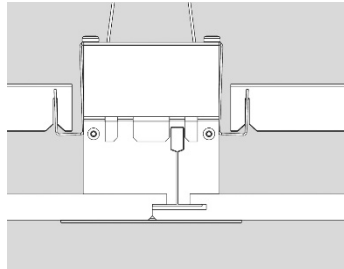

C80-R G2
(+MNT GYPTONE D2)

Skjult 35 mm bæreprøfil med asymmetriske plater

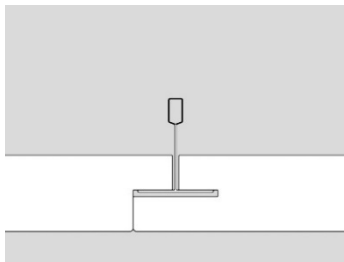

Troldekt T35

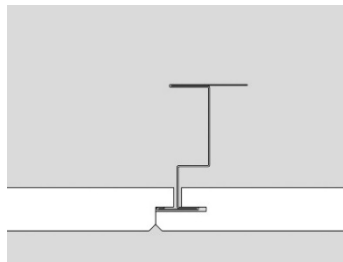

OWA S 9a

Eksempel på leverandører

INLOOK VK-10, Troldekt K5-FN 35, OWA S 9a

Våre tilpassede løsninger

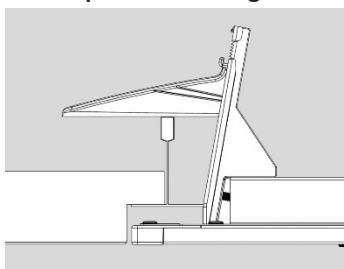

C77-R
(+ MNT C77-R)

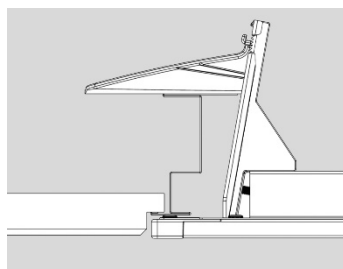

C77-R
(+ MNT C77-R)

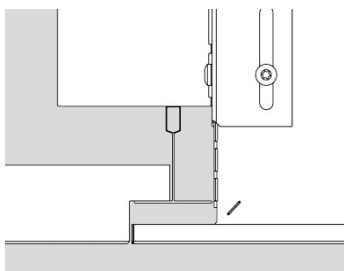

C30-RIC G2

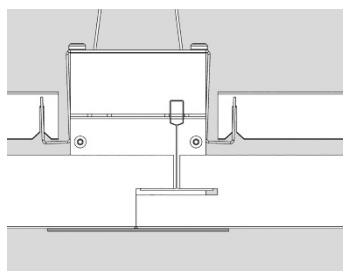

C80-R G2
(+MNT TROLDTEKT T35)

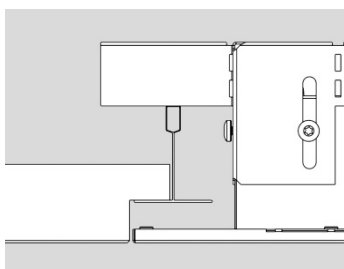

C92-R

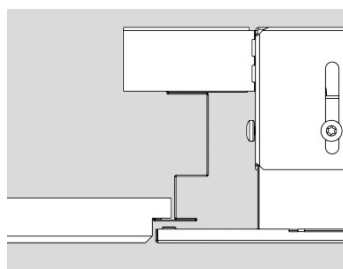

C92-R

Klemskinne 16 mm

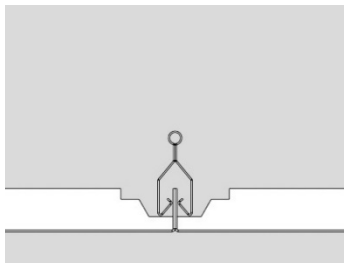

OWA S 22

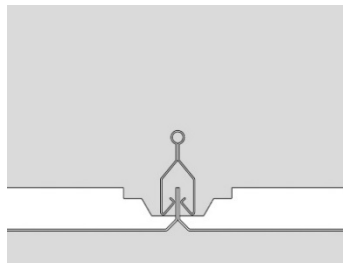

Himlingene kan leveres i 47, 52, 59 eller 67 mm høyde med enten rett kant eller fasett hjørne.

Eksempel på leverandører

Armstrong Q-Clip/R-Clip/S-Clip F, Burgess Clip In A-Bar, Fural K, Lindner LMD-K 420, OWA S 22/31/32, SAS 150

Våre tilpassede løsninger

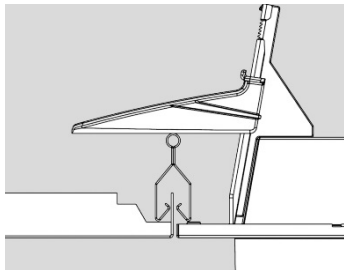

A51-R G2
(+ MNT C20-R G2)

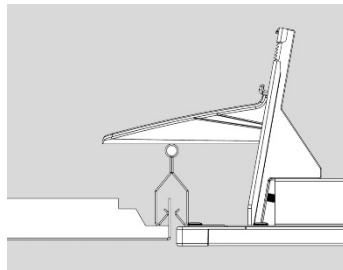

C77-R
(+ MNT C77-R)

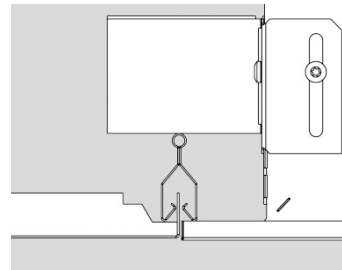

C30-RIC G2

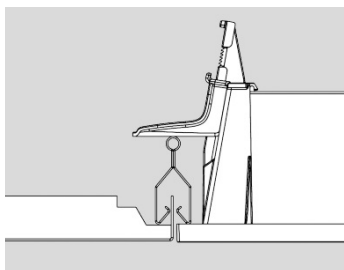

C90-R
(+ MNT C90)

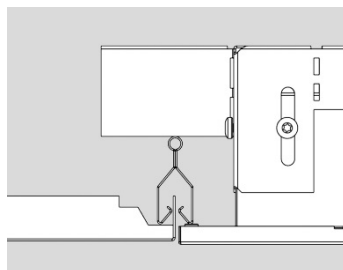

C91-R/C63-R

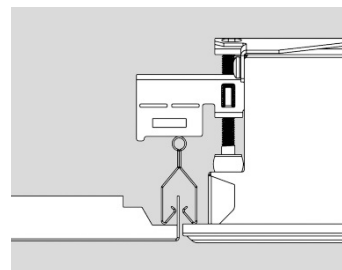

C64-R

Klemskinne 36 mm

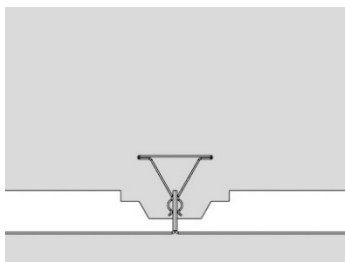

Dampa Clip-In

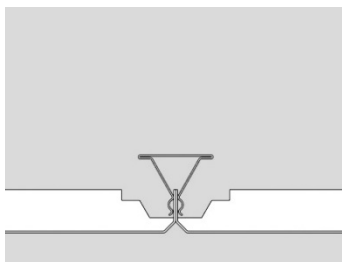

Himlingene kan leveres i 36
(Dampa Clip-In / Meta Klemkassett)
eller 45 mm høyde
(Armstrong T-Clip F / SAS 120)
med enten rett kant eller faset hjørne.

Eksempel på leverandører

Armstrong T-Clip F, Dampa Clip-In, Meta Klemkassett, SAS 120

Våre tilpassede løsninger

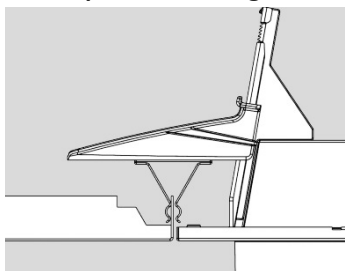

A51-R G2
(+ MNT C20-R G2)

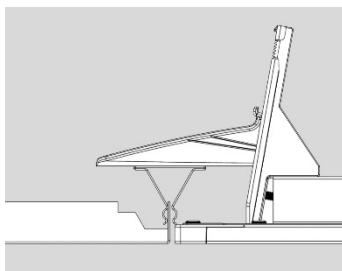

C77-R
(+ MNT C77-R)

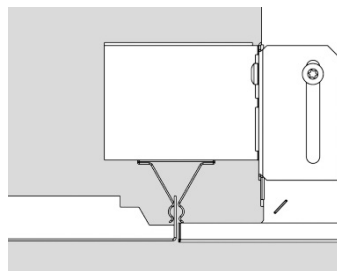

C30-RIC G2

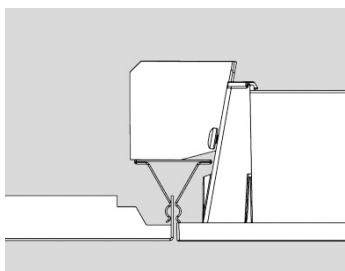

C90-R
(+ MNT SPRING-T36 C90-R)

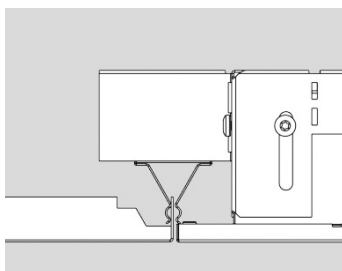

C91-R/C63-R

Klemskinne 45 mm

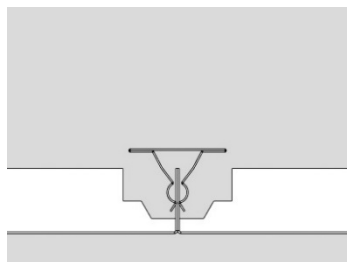

Burgess Clip-In

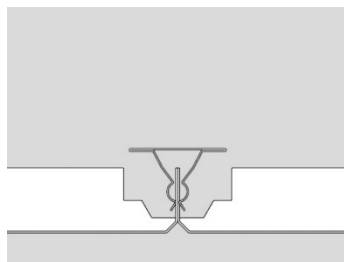

Himlingen kan leveres i 39 (Burgess Clip-In) eller 45 mm høyde (Armstrong Orcal 1800/Burgess Clip-In) med enten rett kant eller faset hjørne.

Eksempel på leverandører

Armstrong Orcal 1800, Burgess Clip-In

Våre tilpassede løsninger

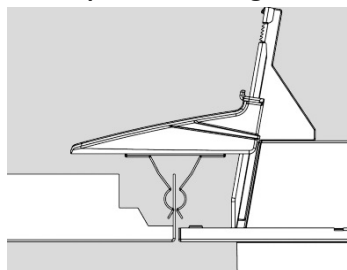

A51-R G2
(+ MNT C20-R G2)

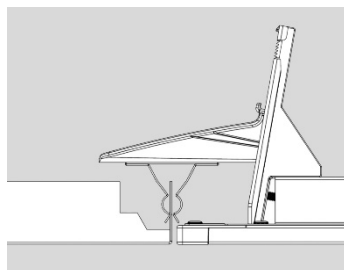

C77-R
(+ MNT C77-R)

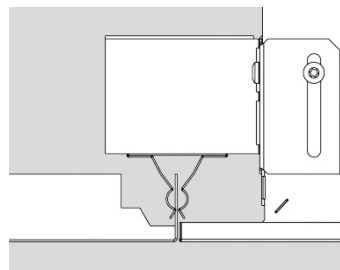

C30-RIC G2

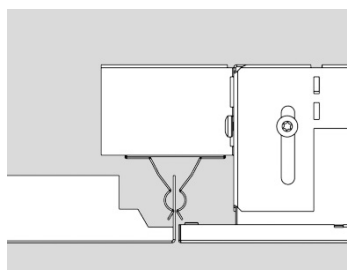

C91-R/C63-R

Ikke demonterbare

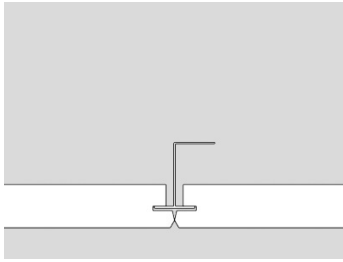

Rockfon C

Eksempel på leverandører

AMF GN, Rockfon C

Våre tilpassede løsninger

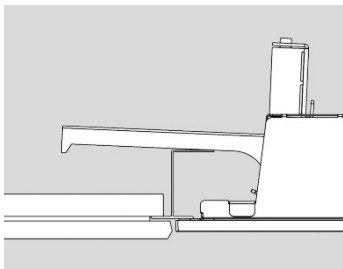

C70-R G2/C85-R
(+ MNT C70-R G2)

Gipshimlinger

Himlinger som ikke er modulære hvor hull i himling må tilpasses armaturens utforming.

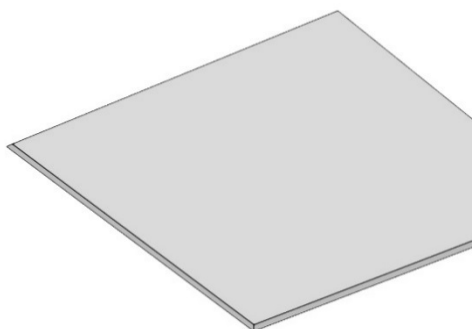

Tilpasset hull i himling

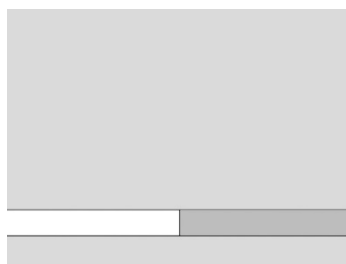

Gipshimling

Våre tilpassede løsninger

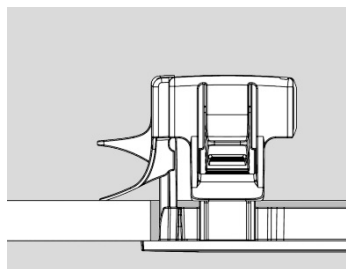

MNT FRAME PLASTERBOARD

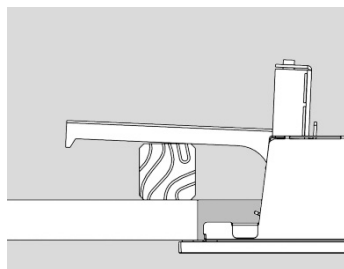

C70-R G2/C85-R
(+ MNT C70-R G2)

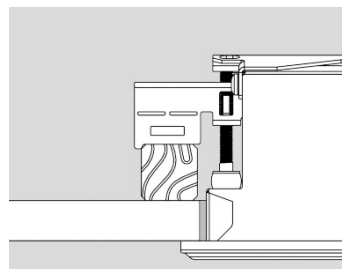

C64-R

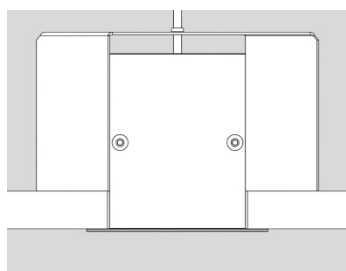

C80-R G2

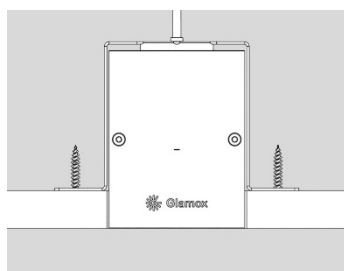

C80-S G2
(+MNT TRIMLESS)

Bandraster

Himlinger med store synlige bæreprøfler som kortendene av himlingsplatene hviler på. Bæreprøflene har forskjellige bredder og utforming, samt at lengdene mellom disse varierer.

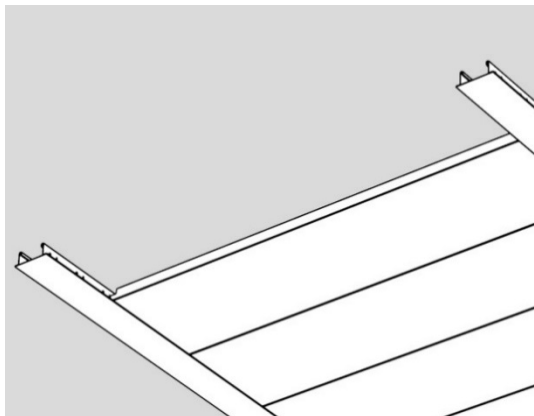

Liggende

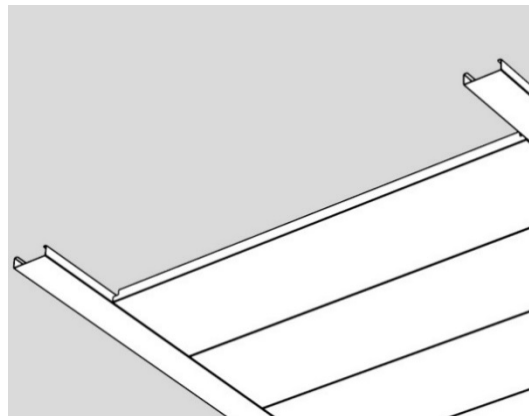

Hengende

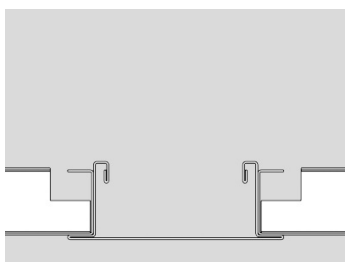

Armstrong liggende

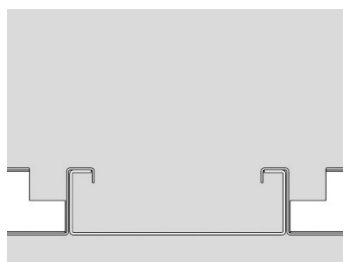

Armstrong hengende

Eksempel på leverandører

Armstrong linear grid, SAS 330

Våre tilpassede løsninger

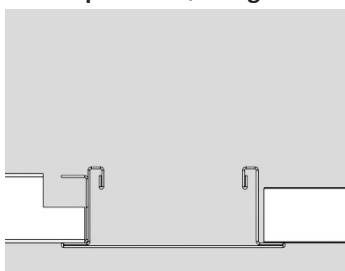

C95-R

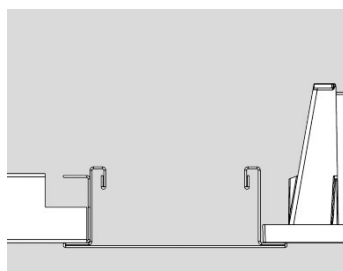

C90-R

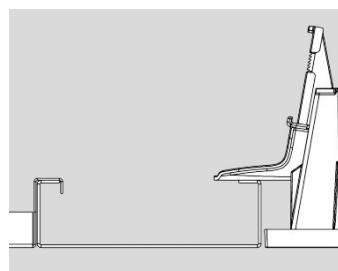

C90-R
(+ MNT C90-R)

For liggende versjon med himlingsplater 300 x 1200 eller 312 x 1250 mm, anbefaler vi å benytte C20-R G2, C95-R, C90-R eller C63-R. For hengende versjon passer C90-R eller C63-R best.

Spilehimlinger

Lineære spilehimlinger finnes i flere modulbredder (vanligvis 100, 150, 200 og 300 mm) som kun har begrensninger i en retning (på tvers). Spilene er profilert på hver side, enten i åpen eller i lukket utførelse. Spilene varierer mye i både høyde og utforming.

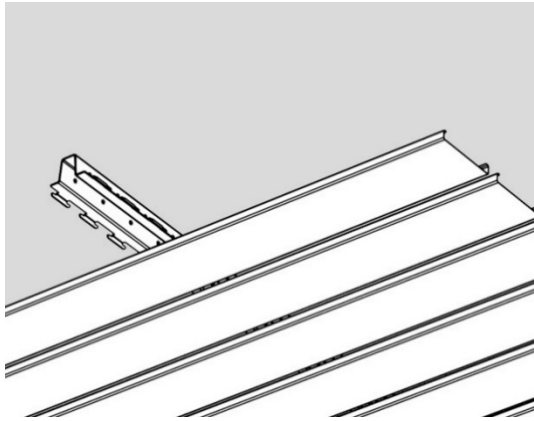

Åpen spilehimling

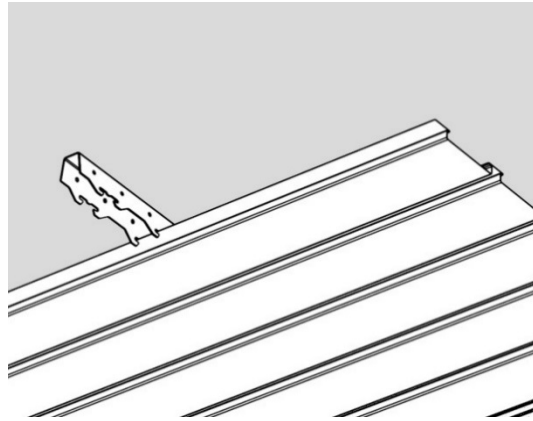

Lukket spilehimling

Eksempel på leverandører

Dampa, Hunter Douglas

Mulige løsninger

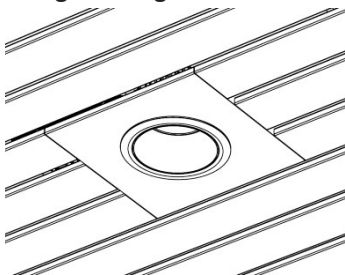

D70-R

Siden spilehimlingene har så mange forskjellige utførelser anbefaler vi å benytte innfelte downlight eller andre løsninger, for eksempel nedhengte armaturer.



Glamox-gruppen

Glamox er et norsk industrikonsern som utvikler, produserer og distribuerer profesjonelle belysningsløsninger for det globale markedet. Vårt mål er å levere bærekraftige produkter og løsninger som forbedrer menneskers prestasjon og komfort.

Høy prestasjon og brukervennlighet

Våre løsninger er designet for å kombinere høy prestasjon og bærekraft med enkelhet og brukervennlighet, samtidig som vi leverer en førsteklasses kundeopplevelse. Vi bruker den nyeste teknologien på innovative måter, og forener den med flere generasjoners erfaring og genuin omsorg for våre kunder og deres ansatte.

Kvalitetsmerkevarer og dedikert support

Vi tilbyr løsninger fra en rekke anerkjente belysningsmerkevarer. Uansett hvilken av dem du velger kan du være trygg på at tett oppfølging av hver enkelt kunde er kjernen i vår virksomhet. Vi gjør ingen forskjell på om bedriften din er et produksjonsanlegg, et fiskefartøy eller et kontorbygg – vår ambisjon er å levere belysning som bidrar til et bedre liv for bedriftene vi leverer til og for menneskene som jobber der.